

## COMPONENT SPECIFICATION

Name	Multilayer Power Inductors	COMPONENT SPECIFICATION		1 / 7
	MLIC-252009-R18M			

### 1. Scope

This specification applies to the MLIC-2520 series Multilayer Power Inductors

### 2. Standard and Atmospheric Conditions

Unless otherwise specified the standard range of atmospheric conditions for making measurements and tests is as follows:

Ambient temperature :  $20 \pm 15^\circ\text{C}$

Relative humidity : 30~70%

If there may be any doubt on the results, measurements shall be made within the following limits :

Ambient temperature :  $25 \pm 5^\circ\text{C}$

Relative humidity : 30~70%

### 3. Ratings

PART NO	INDUCTANCE	SELF-RESONANT FREQUENCY(MHz)	DC RESISTANCE ( $\Omega$ )	※ RATED CURRENT (mA)Max
	AT1 MHz 250mV	Min		
MLIC-2520-R18M	$1.8\mu\text{H} \pm 20\%$	50	$0.13 \pm 25\%$	1500

※The maximum rated current is measured at ambient temperature increasing to  $40^\circ\text{C}$  within 2 hours. Regarding to the inductance variability of rated current, please refer to page 2:

Inductance Vs. DC superposition characteristics.

### 4. Dimensions

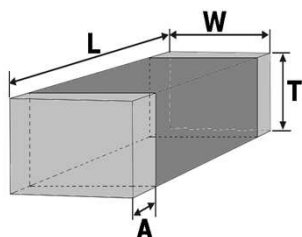

OPERATING TEMP. RANGE :  $-55^\circ\text{C} \sim +125^\circ\text{C}$

STORAGE TEMP. RANGE :  $-40^\circ\text{C} \sim +85^\circ\text{C}$

unit:

mm  
(inch)

TYPE	L	W	T	A(m/m)
MLIC-252009	$2.5 \pm 0.2$ ( $0.098 \pm 0.008$ )	$2 \pm 0.2$ ( $0.079 \pm 0.008$ )	$0.9 \pm 0.1$ ( $0.035 \pm 0.004$ )	$0.4 \sim 0.8$ ( $0.016 \sim 0.031$ )

PLANNED BY	CHECKED BY	APPROVED BY	
Sam	LUN	Jeffery	

# COMPONENT SPECIFICATION

Name	Multilayer Power Inductors	COMPONENT SPECIFICATION		2 / 7
	MLIC-252009-R18M			

## 6. Reflow soldering conditions

- Pre-heating should be in such a way that the temperature difference between solder and ferrite surface is limited to 150°C max. Also cooling into solvent after soldering should be in such a way that the temperature difference is limited to 100°C max.  
Insufficient pre-heating may cause cracks on the ferrite, resulting in the deterioration of product quality.
- Products should be soldered within the following allowable range indicated by the slanted line. The excessive soldering conditions may cause the corrosion of the electrode, when soldering is repeated, allowable time is the accumulated time.

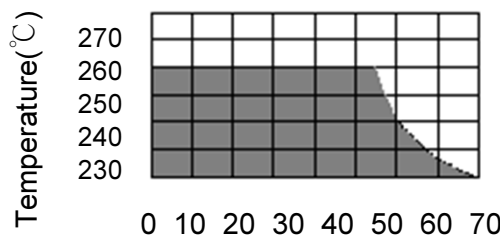

Temperature Profile

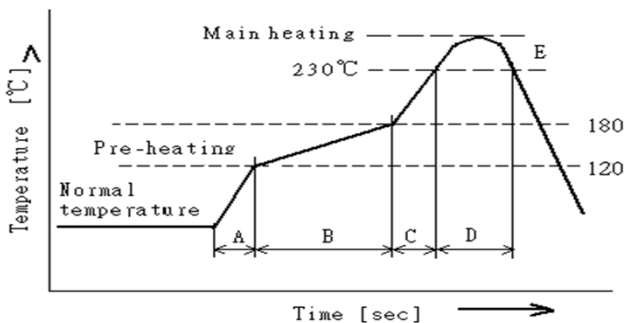

A	Slope of temp. rise	1 to 5	°C/sec
B	Heat time	50 to 150	sec
	Heat temperature	120 to 180	°C
C	Slope of temp. rise	1 to 5	°C/sec
D	Time over 230°C	90~120	sec
E	Peak temperature	255~260	°C
	Peak hold time	10 max.	sec
No. of mounting		3	times

(Melting area of solder)

### 6-1 Reworking with soldering iron

Preheating	150°C, 1 minute
Tip temperature	280°C max.
Soldering time	3 seconds max.
Soldering iron output	30w max.
End of soldering iron	φ 3mm max.

- Reworking should be limited to only one time.

Note : Do not directly touch the products with the tip of the soldering iron in order to prevent the crack on the ferrite material due to the thermal shock.

### 6-2 Solder Volume

Solder shall be used not to be exceed the upper limits as shown below.

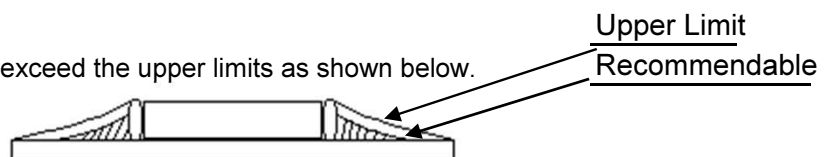

When the amount of solder volume increased, mechanical stress increased as well. Exceeding amount of solder volume may lead to failure of mechanical or electrical characteristics.

# COMPONENT SPECIFICATION

Name	Multilayer Power Inductors	COMPONENT SPECIFICATION		3 / 7
	MLIC-252009-R18M			

## 7. Equipment

### 7-1 Inductance

Inductance shall be measured with HP – 4286A Inductance analyzer or equivalent system

### 7-2 DC RESISTANCE

DC resistance shall be measured using HP 4338 digital milli – ohm meter with 4 terminal method.

## 8. Mechanical Characteristics

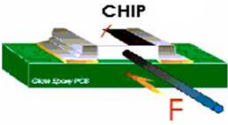
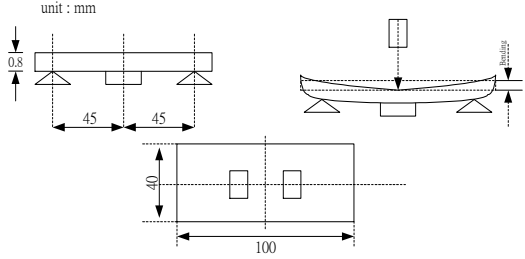
ITEM	Specification	Test Conditions																											
Terminal Strength	Terminal strength does not distort the case shall meet SPEC DC resistance specifications.	<table border="1" style="font-size: small; border-collapse: collapse;"> <thead> <tr> <th>SMD-Size</th> <th>Force g(N)</th> <th>Time Sec.</th> </tr> </thead> <tbody> <tr><td>1005</td><td>300g(3N)</td><td>60+1sec.</td></tr> <tr><td>1608</td><td>500g(5N)</td><td>60+1sec.</td></tr> <tr><td>2012</td><td>600g(6N)</td><td>60+1sec.</td></tr> <tr><td>3216</td><td>1000g(10N)</td><td>60+1sec.</td></tr> <tr><td>3225</td><td>1000g(10N)</td><td>60+1sec.</td></tr> <tr><td>4516</td><td>1000g(10N)</td><td>60+1sec.</td></tr> <tr><td>4532</td><td>1500g(15N)</td><td>60+1sec.</td></tr> <tr><td>5650</td><td>2000g(20N)</td><td>60+1sec.</td></tr> </tbody> </table> 	SMD-Size	Force g(N)	Time Sec.	1005	300g(3N)	60+1sec.	1608	500g(5N)	60+1sec.	2012	600g(6N)	60+1sec.	3216	1000g(10N)	60+1sec.	3225	1000g(10N)	60+1sec.	4516	1000g(10N)	60+1sec.	4532	1500g(15N)	60+1sec.	5650	2000g(20N)	60+1sec.
SMD-Size	Force g(N)	Time Sec.																											
1005	300g(3N)	60+1sec.																											
1608	500g(5N)	60+1sec.																											
2012	600g(6N)	60+1sec.																											
3216	1000g(10N)	60+1sec.																											
3225	1000g(10N)	60+1sec.																											
4516	1000g(10N)	60+1sec.																											
4532	1500g(15N)	60+1sec.																											
5650	2000g(20N)	60+1sec.																											
Substrate Bending Test	SPEC substrate bending test DC resistance shall meet specifications ± 30%.	<p>After soldering a chip to a test substrate, bend the substrate by 2mm hold for 60s and then return.</p> <p>Soldering shall be done in accordance with the recommended PC board pattern and reflow soldering.</p> 																											
Resistance to Solder Heat	No visible damage Electrical characteristics and mechanical characteristics shall be satisfied.  <b>Consult standard MIL-STD-202 METHOD 210</b>	<p>Solder Temp. : 265±3°C</p> <p>Immersion time : 6±1 sec</p> <p>Preheating : 100°C to 150°C, 1 minute.</p> <p>Measurement to be made after keeping at room temp for 24±2 hrs.</p> <p>Solder : Sn-3Ag-0.5Cu</p>																											
Solderability	95% min. coverage of all metallized area  <b>Consult standard J-STD-002</b>	<p>Solder temp. : 240±5°C</p> <p>Immersion time : 3±1 sec</p>																											

# COMPONENT SPECIFICATION

<b>Name</b>	<b>Multilayer Power Inductors</b> <b>MLIC-252009-R18M</b>	<b>COMPONENT SPECIFICATION</b>	<b>4</b> <hr style="width: 100%;"/> <b>7</b>
<p>9. RELIABILITY AND TEST CONDITIONS</p> <p>9-1 HIGH TEMPERATURE RESISTANCE</p> <p style="margin-left: 20px;">a. Performance specification</p> <p style="margin-left: 40px;">1. Appearance : no mechanical damage</p> <p style="margin-left: 40px;">2. Inductance shall be with <math>\pm 20\%</math> of the initial value</p> <p style="margin-left: 20px;">b. Test condition</p> <p style="margin-left: 40px;">1. Temperature: <math>125^{\circ}\text{C} \pm 2^{\circ}\text{C}</math></p> <p style="margin-left: 40px;">2. Testing time : <math>1000 \pm 12</math> hrs</p> <p style="margin-left: 40px;">3. Measurement : After placing at room ambient temperature for 24 hours minimum</p> <p>9-2 Biased Humidity RESISTANCE</p> <p style="margin-left: 20px;">a. Performance specification</p> <p style="margin-left: 40px;">1. Appearance : no mechanical damage</p> <p style="margin-left: 40px;">2. Inductance shall be with <math>\pm 20\%</math> of the initial value</p> <p style="margin-left: 20px;">b. Test condition</p> <p style="margin-left: 40px;">1. Humidity: <math>85 \pm 5\%</math> RH</p> <p style="margin-left: 40px;">2. Temperature: <math>85^{\circ}\text{C} \pm 2^{\circ}\text{C}</math></p> <p style="margin-left: 40px;">3. Testing time: <math>1000 \pm 12</math> hours</p> <p style="margin-left: 40px;">4. Measurement : After placing at room ambient temperature for 24 hours minimum</p> <p style="margin-left: 40px;">5. Apply maximum Rated Voltage and Current</p> <p>9-3 TEMPERATURE CYCLE</p> <p style="margin-left: 20px;">a. Performance specification</p> <p style="margin-left: 40px;">1. Appearance : no mechanical damage</p> <p style="margin-left: 40px;">2. Inductance shall be with <math>\pm 20\%</math> of the initial value</p> <p style="margin-left: 20px;">b. Test condition</p> <p style="margin-left: 40px;">1. Low Temperature: <math>-55^{\circ}\text{C} \pm 5^{\circ}\text{C}</math> kept stabilized for 30 minutes each</p> <p style="margin-left: 40px;">2. High Temperature: <math>125^{\circ}\text{C} \pm 5^{\circ}\text{C}</math> kept stabilized for 30 minutes each</p> <p style="margin-left: 40px;">2. Cycle : 1000 cycles</p> <p style="margin-left: 40px;">3. Measurement : After placing for 24 hours minimum at room ambient temperature</p> <p style="margin-left: 40px;">4. step1. <math>-55^{\circ}\text{C} \text{ temp} \pm 5^{\circ}\text{C}</math> 30<math>\pm</math>3 minutes</p> <p style="margin-left: 80px;">step2. Room temperature 2to5 minutes</p> <p style="margin-left: 80px;">step3. <math>+125^{\circ}\text{C} \text{ temp} \pm 5^{\circ}\text{C}</math> 30<math>\pm</math>3 minutes</p> <p style="margin-left: 80px;">step4. room temperature 2to5 minutes</p> <p>9-4 VIBRATION TEST</p> <p style="margin-left: 20px;">a. Performance specification</p> <p style="margin-left: 40px;">1. Appearance : no mechanical damage</p> <p style="margin-left: 40px;">2. Inductance shall be with <math>\pm 20\%</math> of the initial value</p> <p style="margin-left: 20px;">b. Test condition</p> <p style="margin-left: 40px;">1. Frequency and Amplitude: 10-2000-10Hz</p> <p style="margin-left: 40px;">2. Direction: X, Y, Z.</p> <p style="margin-left: 40px;">3. Test duration: 5g's for 20 minutes, 12 cycles each of 3 orientations.</p> <p>9-5 Mechanical Shock TEST</p> <p style="margin-left: 20px;">a. Performance specification</p> <p style="margin-left: 40px;">1. Appearance : no mechanical damage</p> <p style="margin-left: 40px;">2. Inductance shall be with <math>\pm 20\%</math> of the initial value</p> <p style="margin-left: 20px;">b. Test condition</p> <p style="margin-left: 40px;">1. peak acceleration : 1500 g's</p> <p style="margin-left: 40px;">2. Duration of pulse : 0.5 ms</p> <p style="margin-left: 40px;">3. Waveform : Half-sine</p> <p style="margin-left: 40px;">4. Velocity change : 15.4 ft/sec</p> <p style="margin-left: 40px;">5. Direction : X , Y , Z ( 3axes/3 times )</p> <p>9-6 Operational Life</p> <p style="margin-left: 20px;">a. Performance specification</p> <p style="margin-left: 40px;">1. Appearance : no mechanical damage</p> <p style="margin-left: 40px;">2. Inductance shall be with <math>\pm 20\%</math> of the initial value</p> <p style="margin-left: 20px;">b. Test condition</p> <p style="margin-left: 40px;">1. Temperature: <math>125^{\circ}\text{C} \pm 2^{\circ}\text{C}</math></p> <p style="margin-left: 40px;">2. Testing time : <math>1000 \pm 12</math> hrs</p> <p style="margin-left: 40px;">3. Measurement : After placing at room ambient temperature for 24 hours minimum</p> <p style="margin-left: 40px;">4. Apply maximum Rated Voltage and Current</p> <p>9-7 Electrostatic discharge test</p> <p style="margin-left: 20px;">a. Performance specification</p> <p style="margin-left: 40px;">1. Appearance : no mechanical damage</p> <p style="margin-left: 40px;">2. Inductance shall be with <math>\pm 20\%</math> of the initial value</p> <p style="margin-left: 20px;">b. Test condition</p> <p style="margin-left: 40px;">1. ESD voltage: 15k volts</p> <p style="margin-left: 40px;">2. Mode 1: 150 pF/330 Ohm</p> <p style="margin-left: 40px;">3. Mode 2: 150 pF/2000 Ohm</p>			

# COMPONENT SPECIFICATION

Name	Multilayer Power Inductors	COMPONENT SPECIFICATION	5 / 7
	MLIC-252009-R18M		

### 10-1 DIMENSIONS

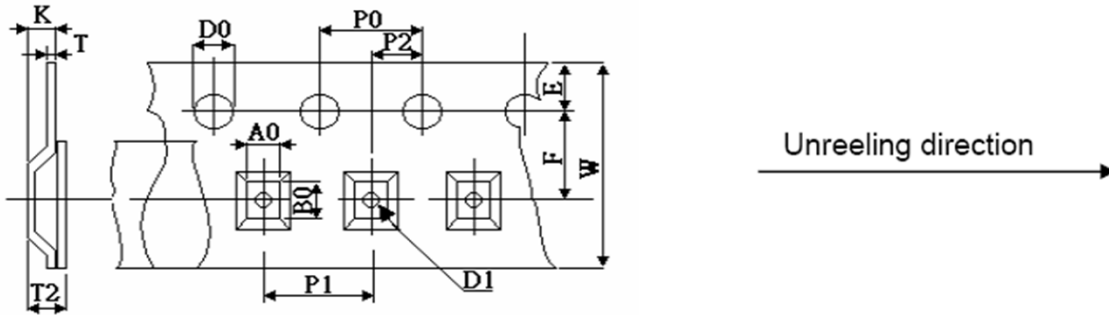

A0	B0	W	F	E	P1	P2	P0	D0	D1	K	T	T2
2.2	2.85	8.0	3.5	1.75	4.0	2.00	4.0	1.55	1.00	1.37	0.2	1.40
±0.1	±0.1	±0.1	±0.05	±0.1	±0.1	±0.05	±0.1	±0.05	±0.1	±0.15	±0.05	±0.2

### 10-2 LEADER AND TRAILER TAPE

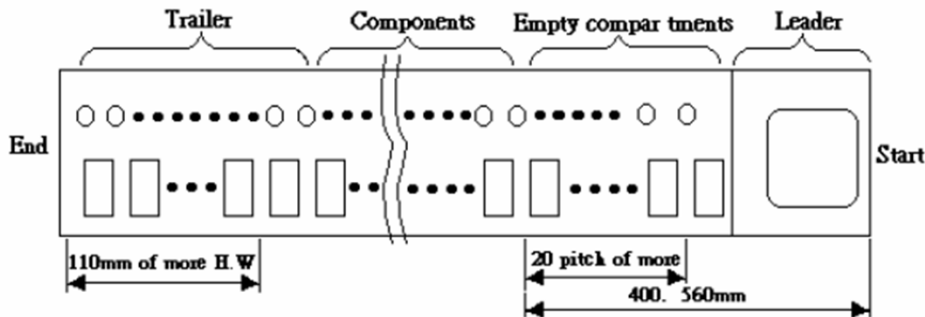

### 10-3 DIRECTION THE DIRECTION SHALL BE SEEN FROM THE TOP OF COVER TAPE

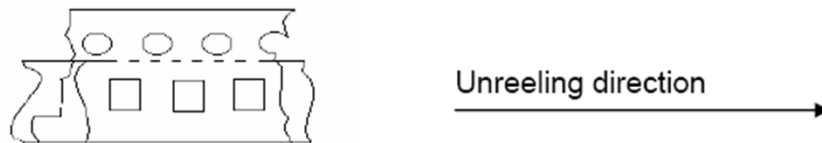

### 10-4 REELS

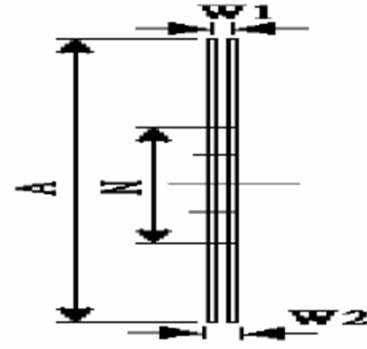
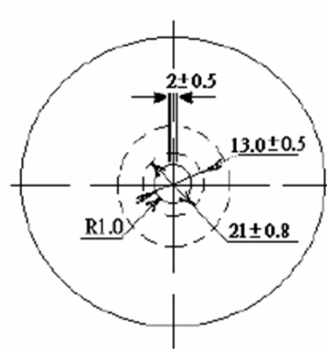

UNIT:mm

A	178 ±2.0
N	50 MIN
W1	10 ±1.5
W2	20 MAX

PACKING QTY.  
3,000 PCS REEL

## COMPONENT SPECIFICATION

Name	Multilayer Power Inductors	COMPONENT SPECIFICATION		6 / 7
	MLIC-252009-R18M			

### 10-5 PEELING STRENGTH OF COVER TAPE

Cover tape	(10g~100g)
------------	------------

165°~180°

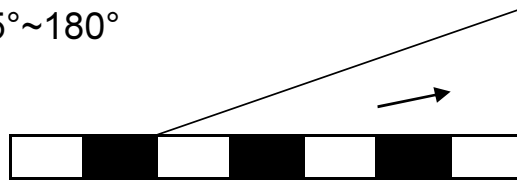

#### Test condition

1. peel angle : 165°~180° vs carrier tape
2. peel speed : 300mm/min

#### 11. Packaging

1. Tape & Reel packaging in component specification 6/8
- 2) Reel and a bag of desiccant shall be packed in Nylon or plastic bag
- 3) Maximum of 5 reels shall be packaged in a inner box
- 4) Maximum of 6 inner box shall be packaged in a outer box

#### 12. Reel Label

Producing the goods label needs to indicate (1 ) Pb Free (2) RoHS Compliant

## COMPONENT SPECIFICATION

NAME	Multilayer Power Inductors  MLIC-252009-R18M	COMPONENT SPECIFICATION	7 / 7
<p><b>13. Storage</b></p> <p>13-1 The solderability of the external electrode may be deteriorated if packages are stored where they are exposed to high humidity. Packages must be stored at 40°C or less and 70% RH or less.</p> <p>13-2 The solderability of the external electrode may be deteriorated if packages are stored where they are exposed to dust or harmful gas (hydrogen chloride, sulfurous acid gas or hydrogen sulfide).</p> <p>13-3 Packaging material may be deformed if packages are stored where they are exposed to heat or direct sun – light.</p> <p>13-4 Minimum packages, such as polyvinyl heat – seal packages shall not be opened until just before they are used. If opened, use the reels as soon as possible.</p> <p>13-5 Solderability specified in component specification 4/8 shall be for 12 months from the date of delivery on condition that they are stored at the environment specified clause 13-1 &amp; 13-2.</p> <p>For those parts which passed more than 12 months shall be checked solderability before it is used.</p>			