

# COPPER BERYLLIUM FINGER STRIPS/CB



## Various selection of Copper Beryllium Finger Strips

### Feature

- Copper beryllium owes its wide range of application to the unique performance qualities it has:
  - extraordinary elasticity
  - strength
  - fatigue strength
  - high conductivity
  - resistance against environmental influences such as ozone, epipolar rays and light, also against solvents and corrosion.
- Furthermore, copper beryllium can be used under a wide temperature range and is not burnable or flammable. It does not evolve gas either. If handled correctly, it acts self purifying, for example when it is employed as a door shield for opening and closing.

### Technical Data

Specific gravity	8,4 g/cm <sup>3</sup>
Fusing point	900 °C
Coefficient of expansion (20-200 °C)	17 10 <sup>-6</sup> /°C
Thermal conductivity	0.27 cal/cm s °C; 1.13 W/cm °C
Diamond pyramid hardness	350-430 kp/mm <sup>2</sup>
Tensile strength	1200-1450 N/mm <sup>2</sup>
Fatigue strength, load application 10 <sup>8</sup>	250-290 N/mm <sup>2</sup>
Modulus of elasticity	135000 N/mm <sup>2</sup>
Torsion modulus	47000 N/mm <sup>2</sup>
Spring bending limit	820-950 N/mm <sup>2</sup>
Electric conductivity	12.5-13 m/Ωmm <sup>2</sup>

Plating finishes
-01 Bright finish
-02 Tin plated
-03 Silver plated
-04 Nickel plated
-05 Gold plated

Ordering information	Part No.	Finish-ID.	length (mm)		
	CB-	xxxx	-	xx	-

### CB-0002

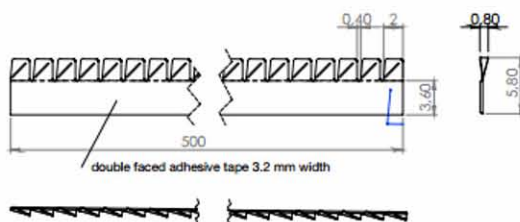

### CB-0004

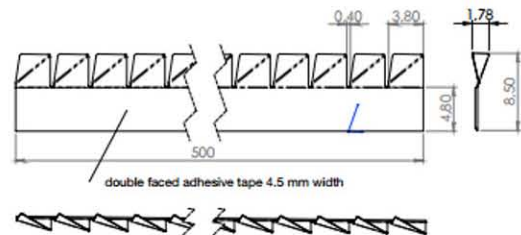

### CB-0005

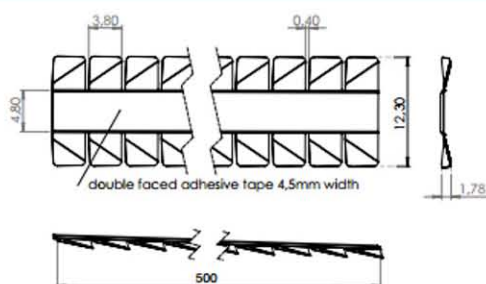

### CB-0006

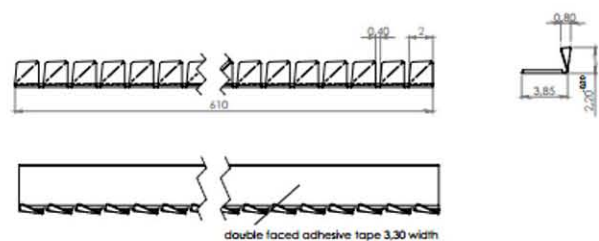

Unit: mm

CB-0049

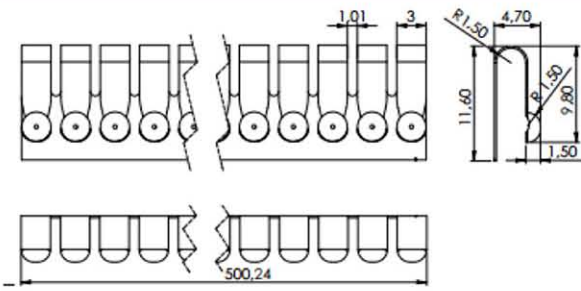

CB-0050

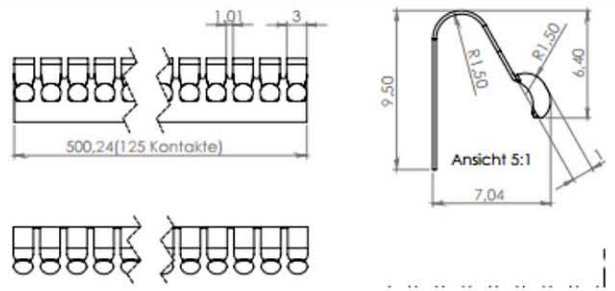

CB-0051

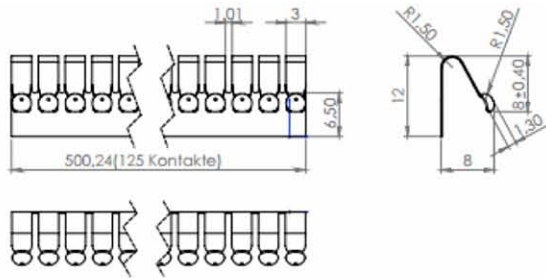

CB-0057

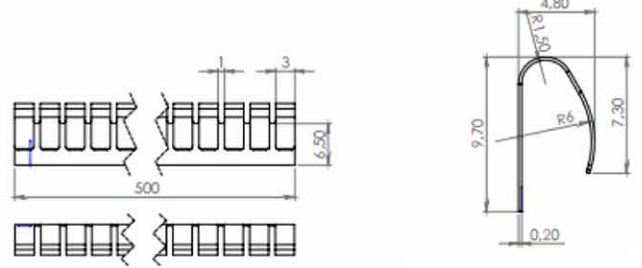

CB-0059

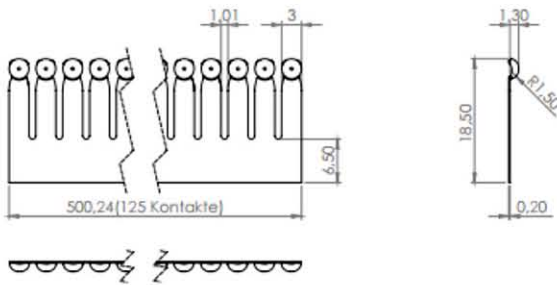

CB-0060

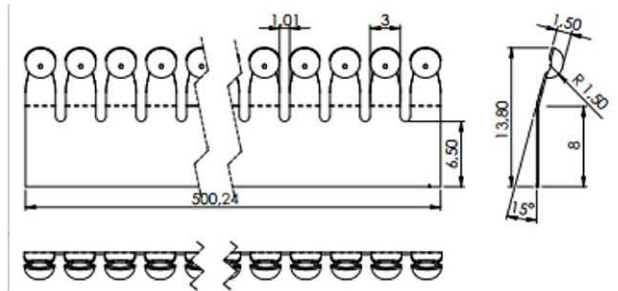

CB-0061

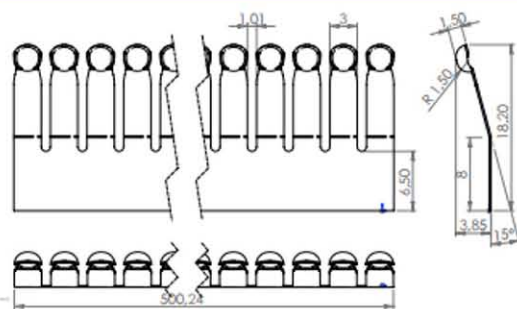

CB-0062

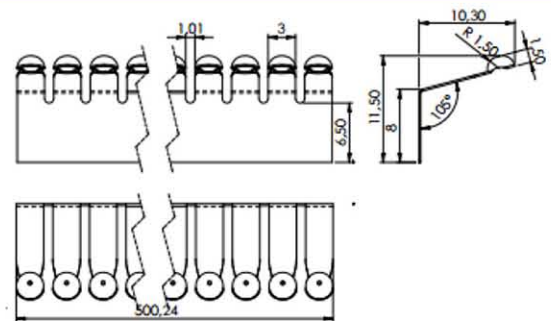

CB-0063

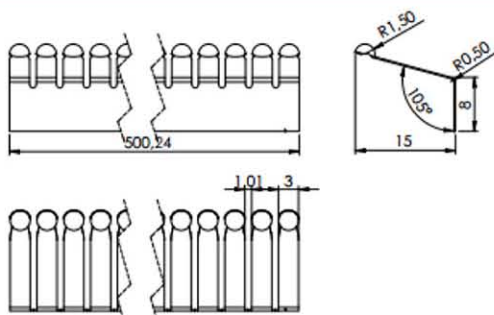

**CB-0027**

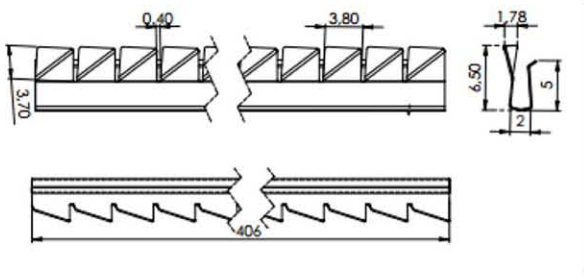

**CB-0034**

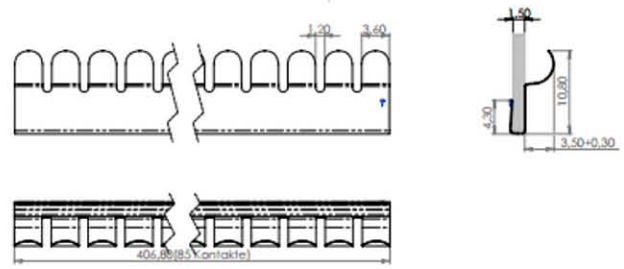

**CB-0036**

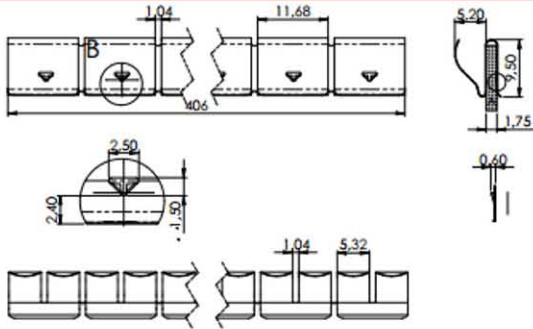

**CB-0037**

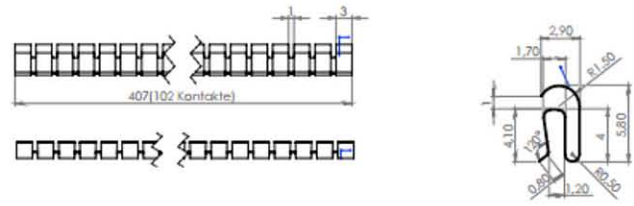

**CB-0038**

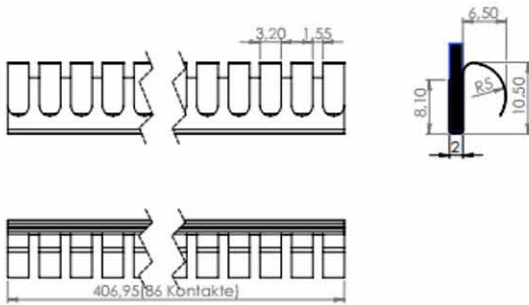

**CB-0039**

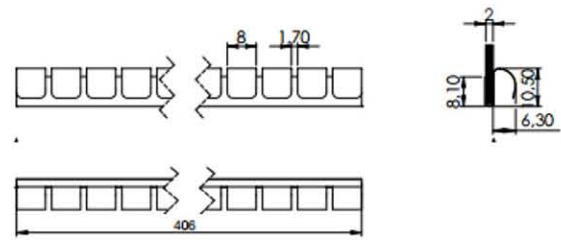

**CB-0042**

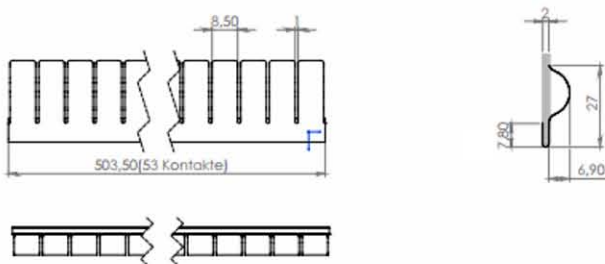

**CB-0044**

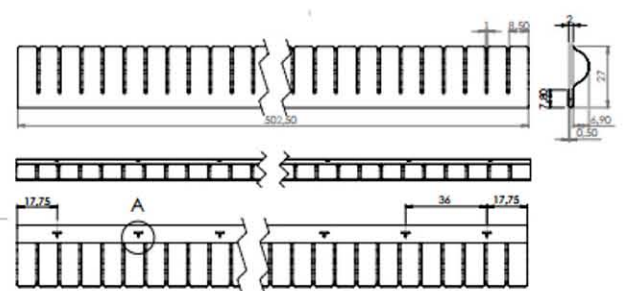

**CB-0045**

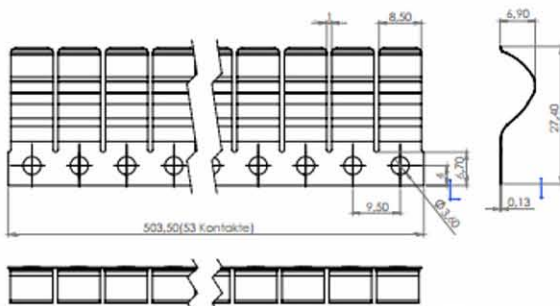

**CB-0048**

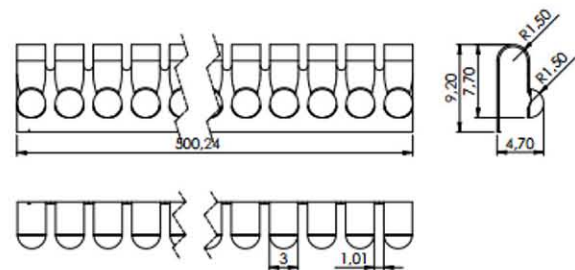



# COPPER BERYLLIUM FINGER STRIPS/CB

CB-0007

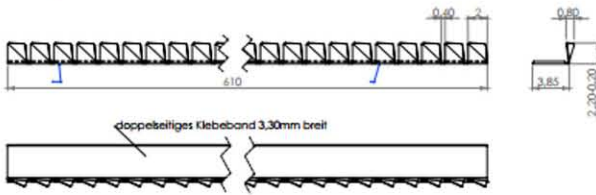

CB-0008

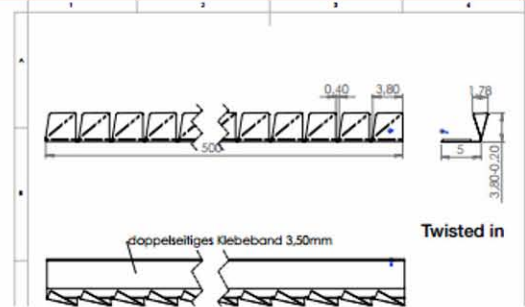

CB-0009

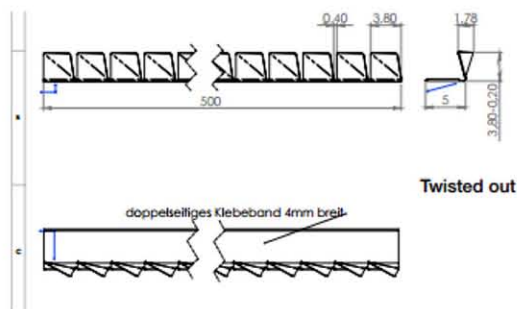

CB-0010

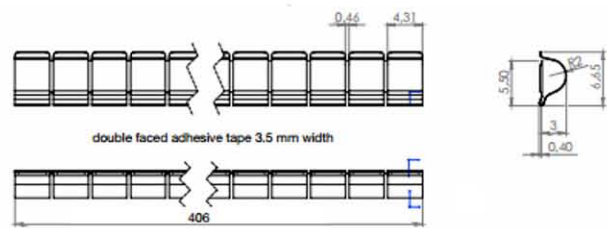

CB-0011

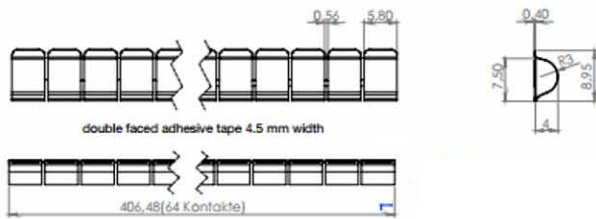

CB-0012

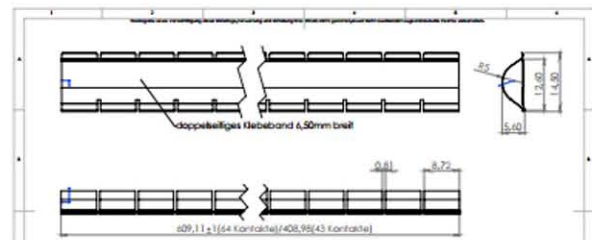

CB-0013

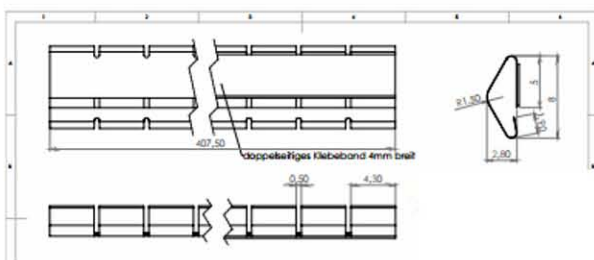

CB-0014

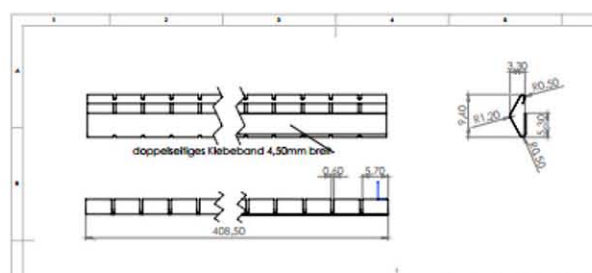

CB-0015



CB-0016

