

COPPER BERYLLIUM FINGER STRIPS/CB



Various selection of Copper Beryllium Finger Strips

Feature

- Copper beryllium owes its wide range of application to the unique performance qualities it has:
 - extraordinary elasticity
 - strength
 - fatigue strength
 - high conductivity
 - resistance against environmental influences such as ozone, epipolar rays and light, also against solvents and corrosion.
- Furthermore, copper beryllium can be used under a wide temperature range and is not burnable or flammable. It does not evolve gas either. If handled correctly, it acts self purifying, for example when it is employed as a door shield for opening and closing.

Technical Data

| | |
|--|--------------------------------|
| Specific gravity | 8,4 g/cm ³ |
| Fusing point | 900 °C |
| Coefficient of expansion (20-200 °C) | 17 10 ⁻⁶ /°C |
| Thermal conductivity | 0.27 cal/cm s °C; 1.13 W/cm °C |
| Diamond pyramid hardness | 350-430 kp/mm ² |
| Tensile strength | 1200-1450 N/mm ² |
| Fatigue strength, load application 10 ⁸ | 250-290 N/mm ² |
| Modulus of elasticity | 135000 N/mm ² |
| Torsion modulus | 47000 N/mm ² |
| Spring bending limit | 820-950 N/mm ² |
| Electric conductivity | 12.5-13 m/Ωmm ² |

| Plating finishes |
|-------------------|
| -01 Bright finish |
| -02 Tin plated |
| -03 Silver plated |
| -04 Nickel plated |
| -05 Gold plated |

| Ordering information | Part No. | Finish-ID. | length (mm) | | |
|----------------------|----------|------------|-------------|----|---|
| | CB- | xxxx | - | xx | - |

CB-0002

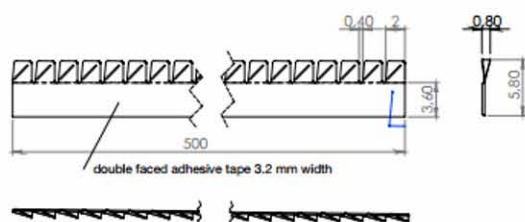

CB-0004

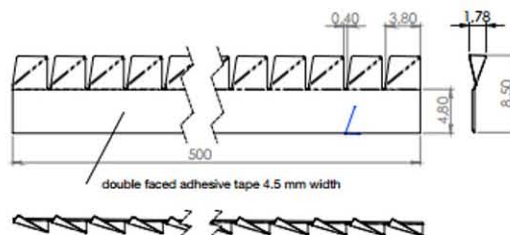

CB-0005

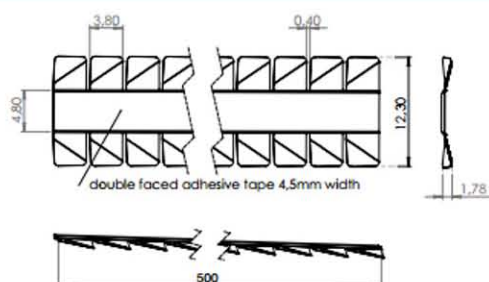

CB-0006

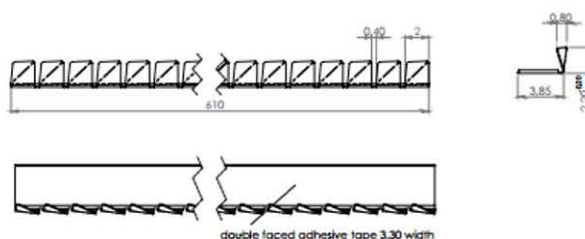

Unit: mm

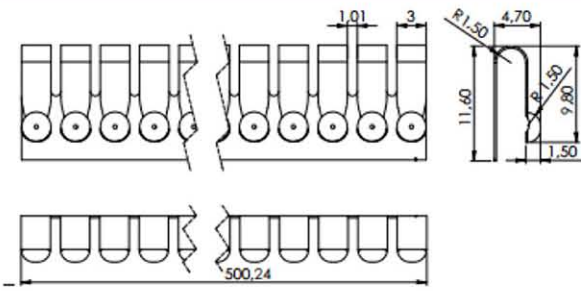
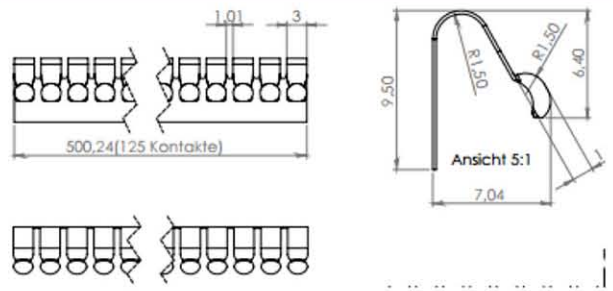
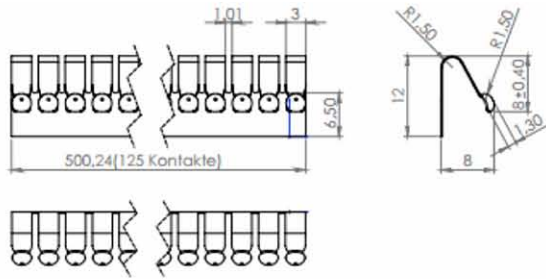
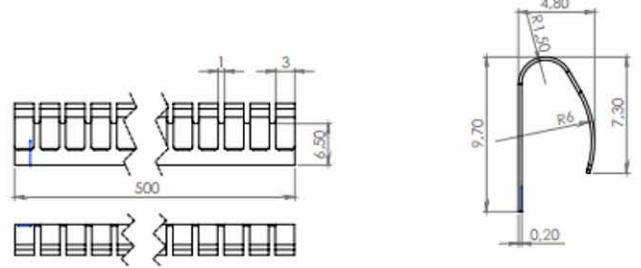
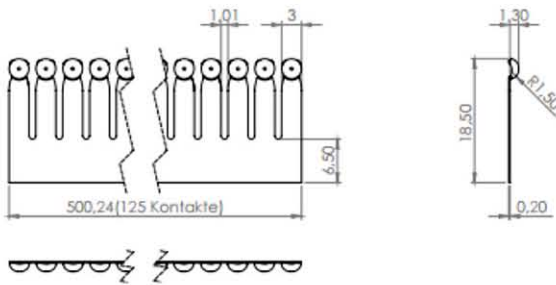
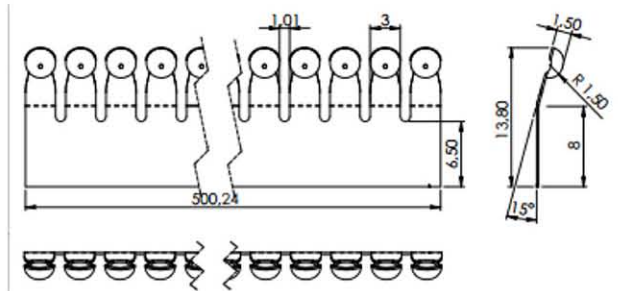
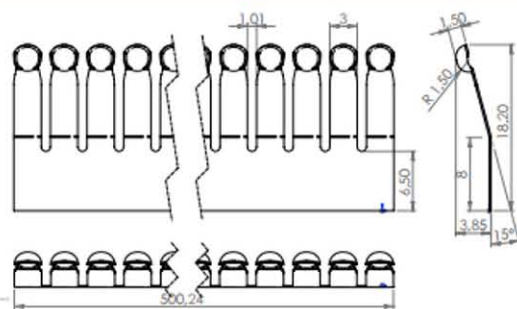
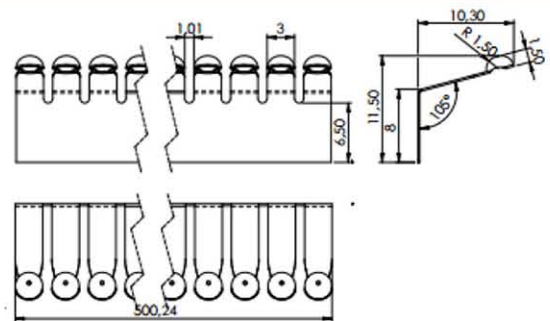
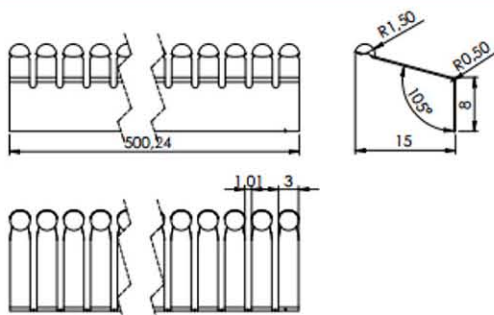
CB-0049**CB-0050****CB-0051****CB-0057****CB-0059****CB-0060****CB-0061****CB-0062****CB-0063**

CB-0027

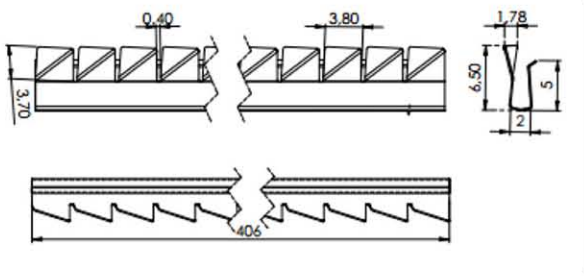

CB-0034

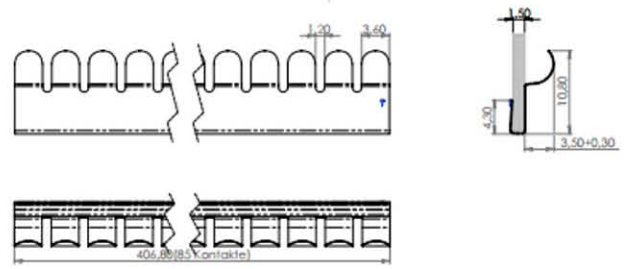

CB-0036

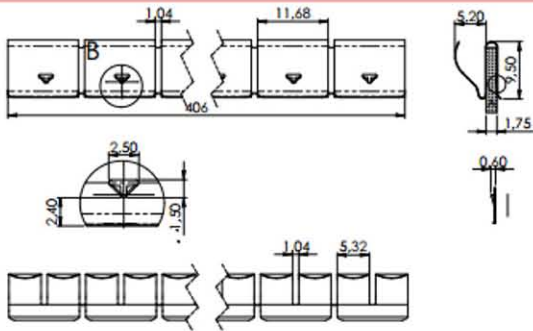

CB-0037

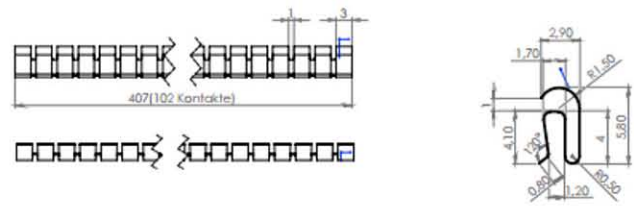

CB-0038

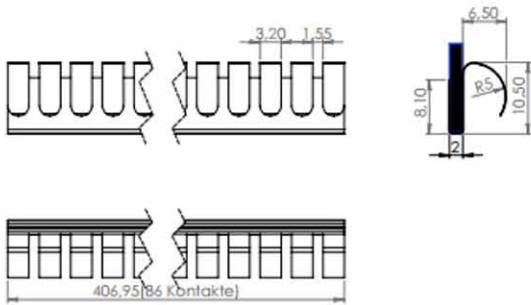

CB-0039

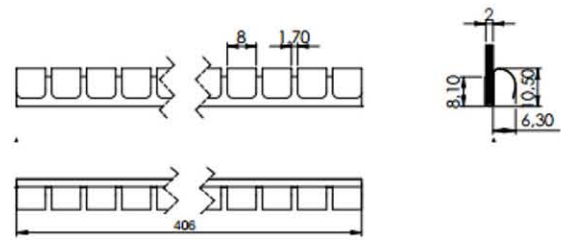

CB-0042

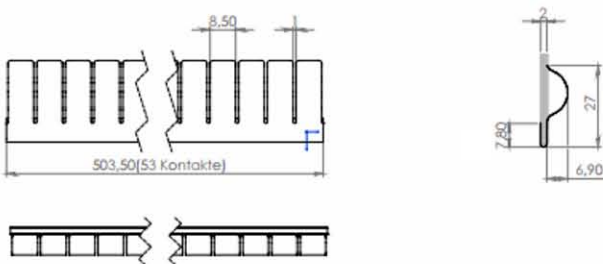

CB-0044

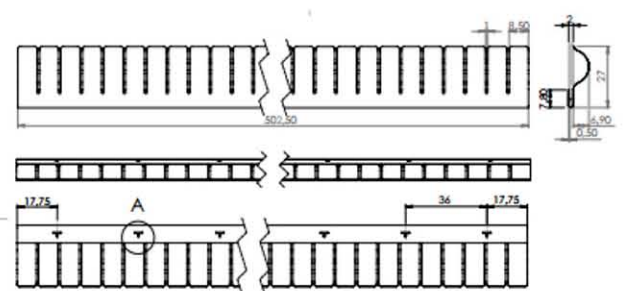

CB-0045

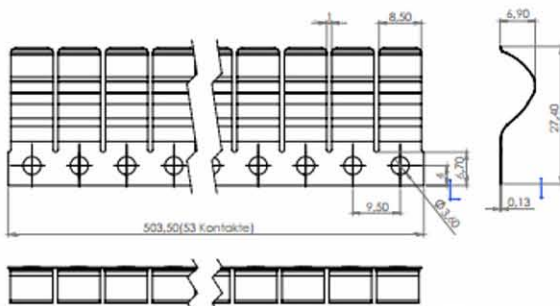

CB-0048

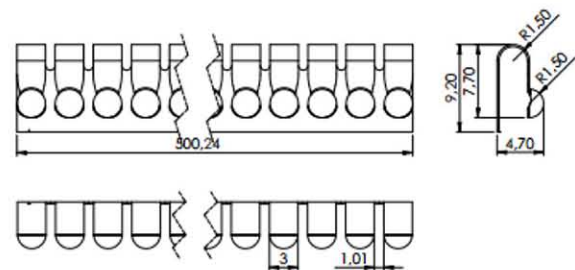

Unit: mm

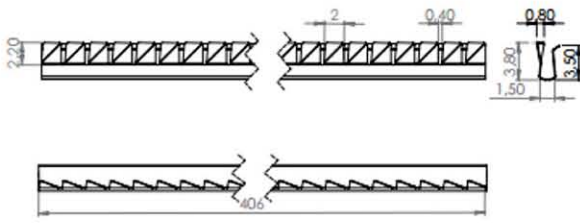
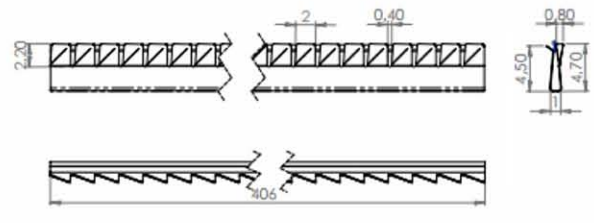
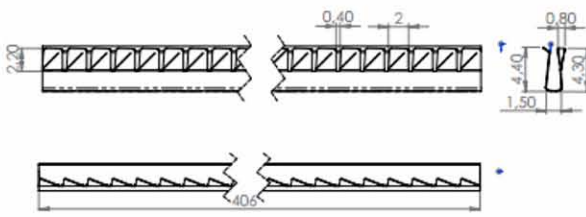
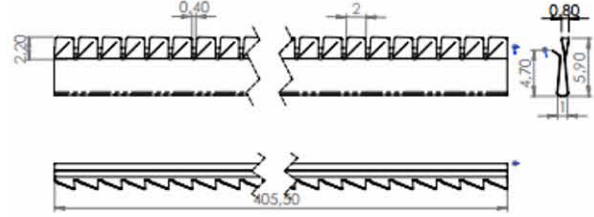
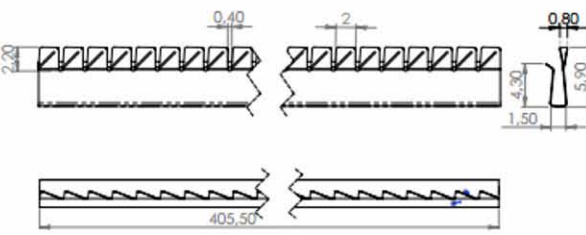
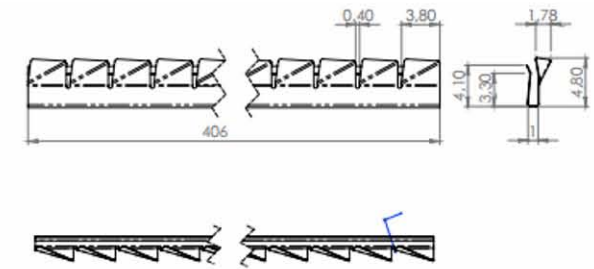
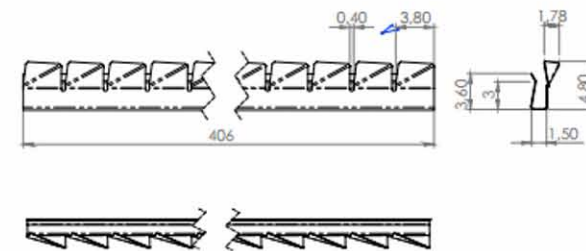
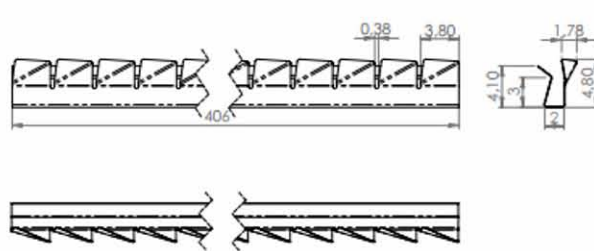
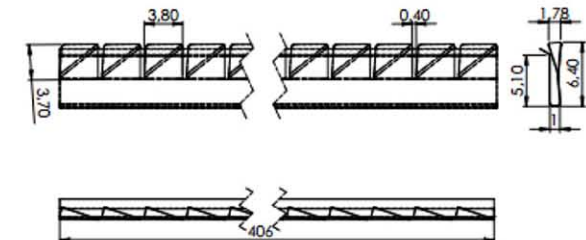
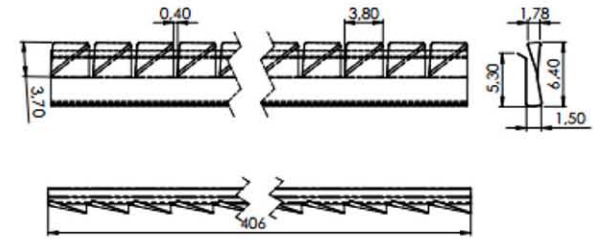
CB-0017**CB-0018****CB-0019****CB-0020****CB-0021****CB-0022****CB-0023****CB-0024****CB-0025****CB-0026**

COPPER BERYLLIUM FINGER STRIPS/CB

CB-0007

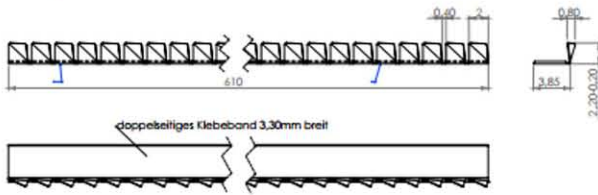

CB-0008

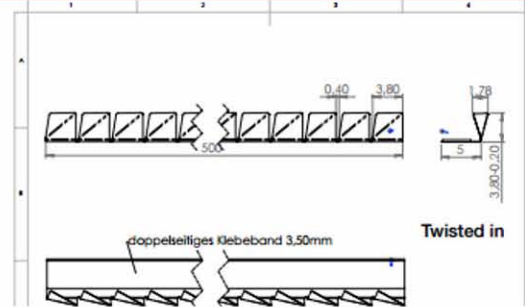

CB-0009

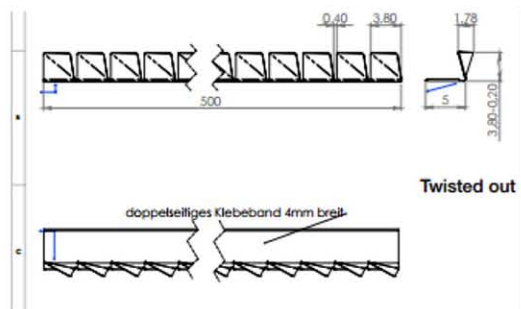

CB-0010

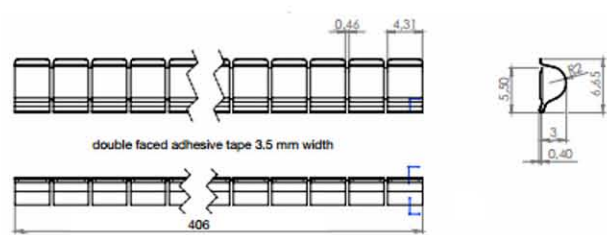

CB-0011

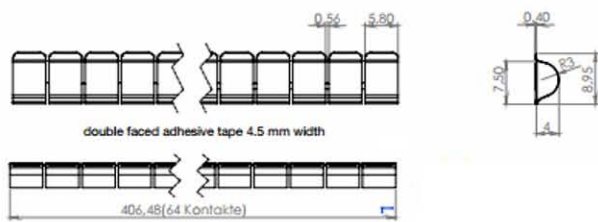

CB-0012

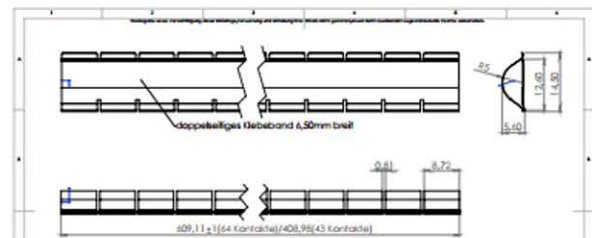

CB-0013

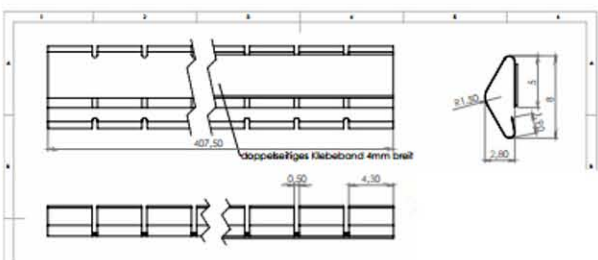

CB-0014

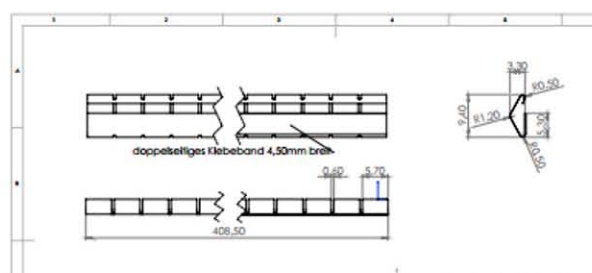

CB-0015



CB-0016

