

COPPER BERYLLIUM FINGER STRIPS/CB



Various selection of Copper Beryllium Finger Strips

Feature

- Copper beryllium owes its wide range of application to the unique performance qualities it has:
 - extraordinary elasticity
 - strength
 - fatigue strength
 - high conductivity
 - resistance against environmental influences such as ozone, epipolar rays and light, also against solvents and corrosion.
- Furthermore, copper beryllium can be used under a wide temperature range and is not burnable or flammable. It does not evolve gas either. If handled correctly, it acts self purifying, for example when it is employed as a door shield for opening and closing.

Technical Data

Specific gravity	8,4 g/cm ³
Fusing point	900 °C
Coefficient of expansion (20-200 °C)	17 10 ⁻⁶ /°C
Thermal conductivity	0.27 cal/cm s °C; 1.13 W/cm °C
Diamond pyramid hardness	350-430 kp/mm ²
Tensile strength	1200-1450 N/mm ²
Fatigue strength, load application 10 ⁸	250-290 N/mm ²
Modulus of elasticity	135000 N/mm ²
Torsion modulus	47000 N/mm ²
Spring bending limit	820-950 N/mm ²
Electric conductivity	12.5-13 m/Ωmm ²

Plating finishes
-01 Bright finish
-02 Tin plated
-03 Silver plated
-04 Nickel plated
-05 Gold plated

Ordering information	Part No.	Finish-ID.	length (mm)
	CB-xxxx	-xx	-xxxxx

CB-0002

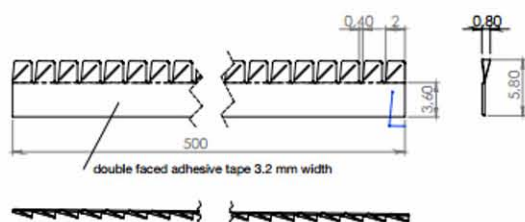

CB-0004

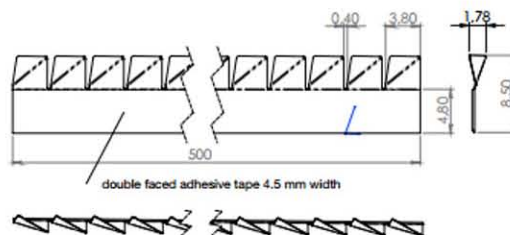

CB-0005

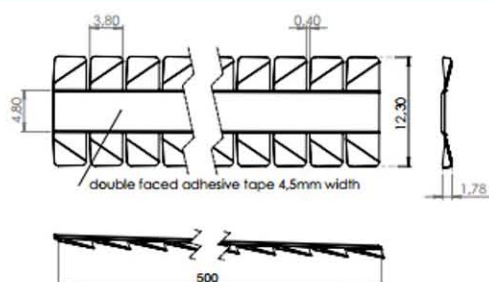

CB-0006

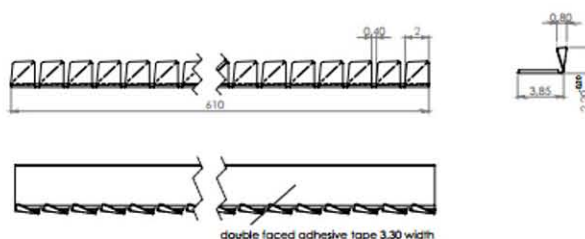

Unit: mm

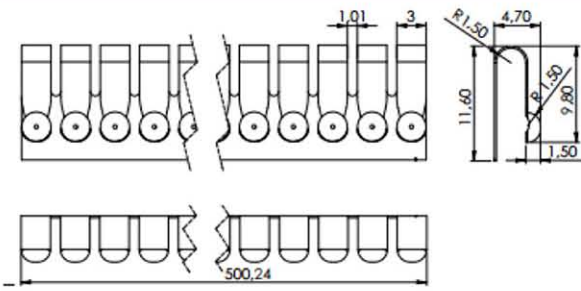
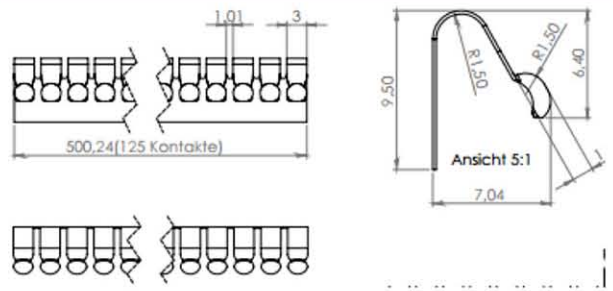
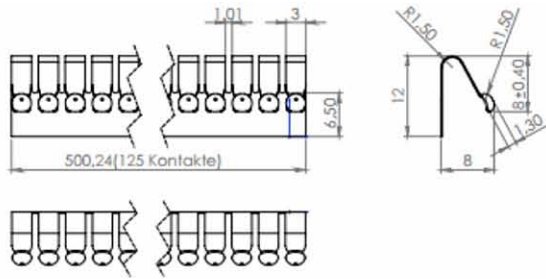
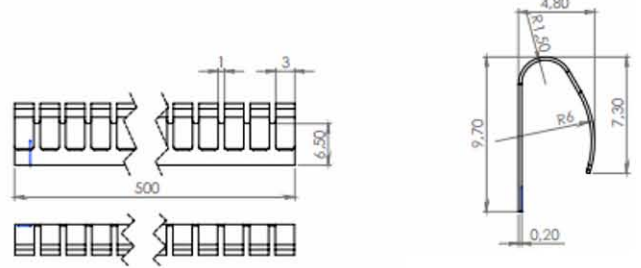
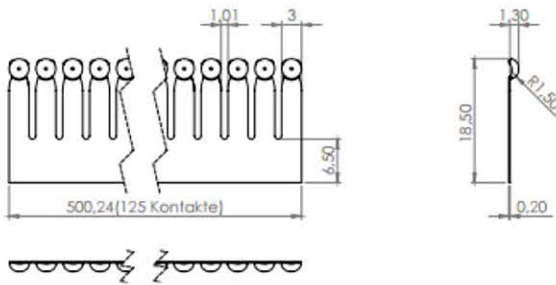
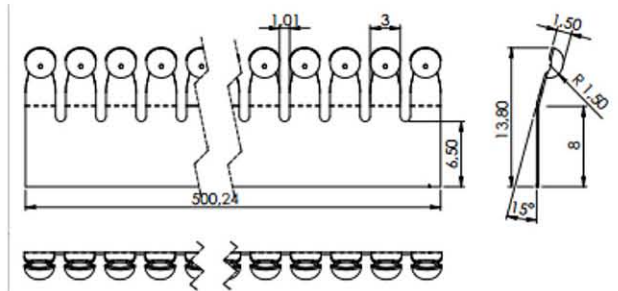
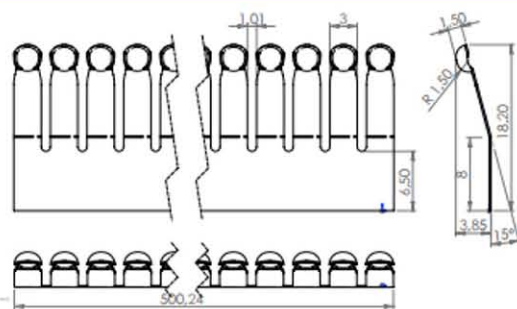
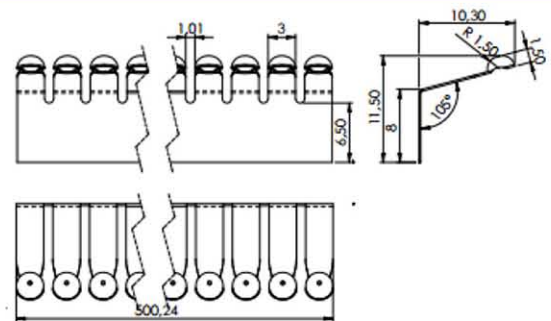
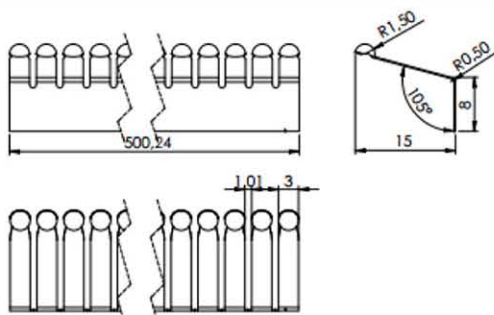
CB-0049**CB-0050****CB-0051****CB-0057****CB-0059****CB-0060****CB-0061****CB-0062****CB-0063**

Unit: mm

CB-0027

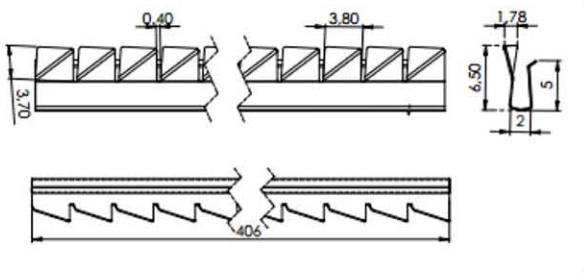

CB-0034

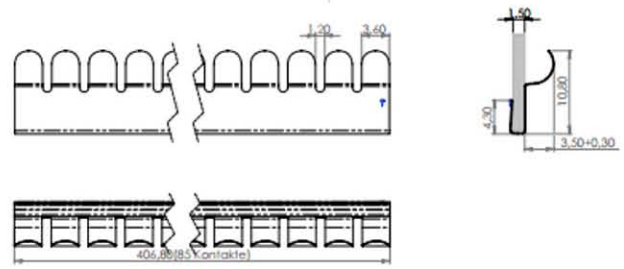

CB-0036

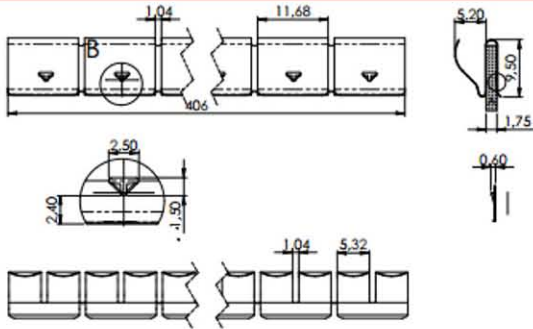

CB-0037

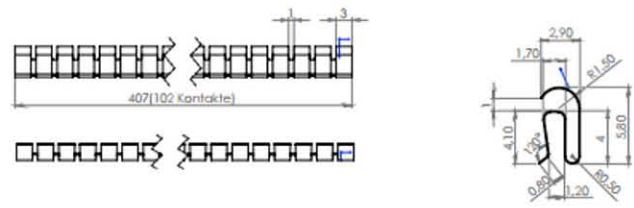

CB-0038

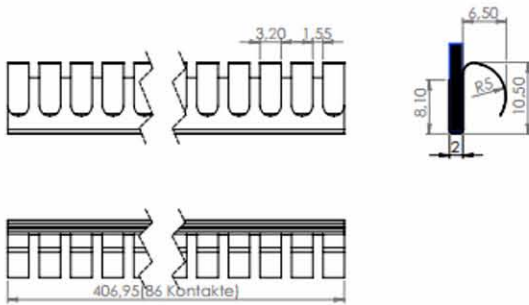

CB-0039

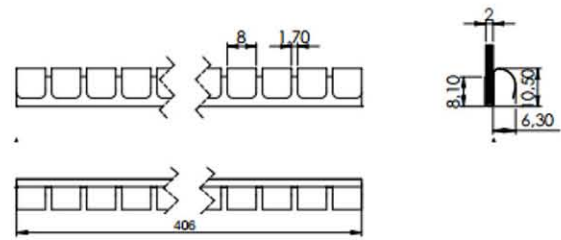

CB-0042

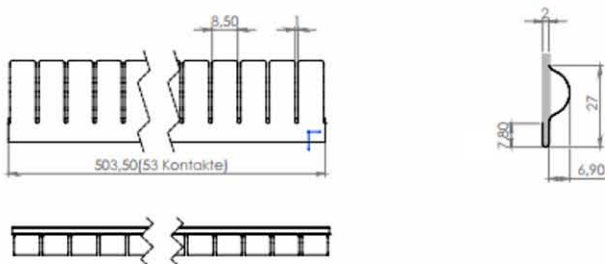

CB-0044

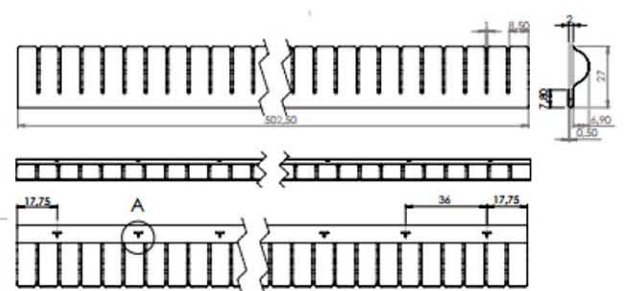

CB-0045

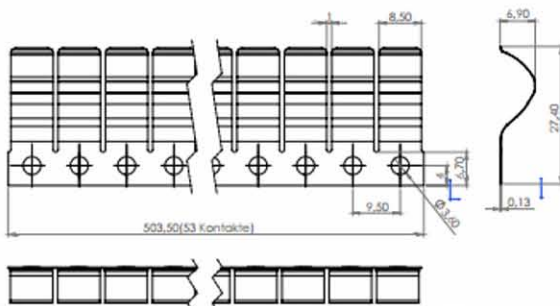

CB-0048

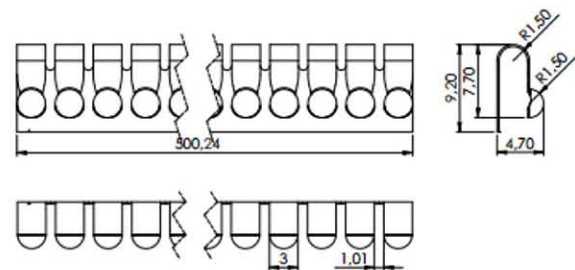

Unit: mm

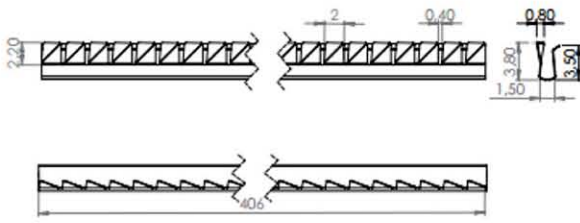
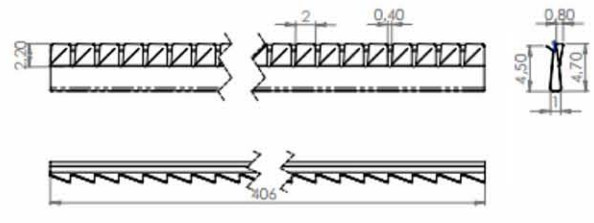
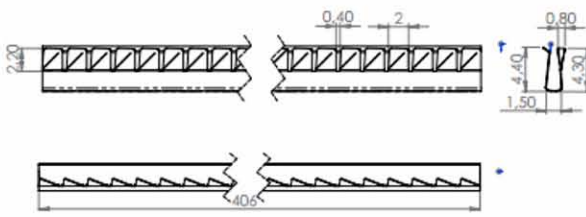
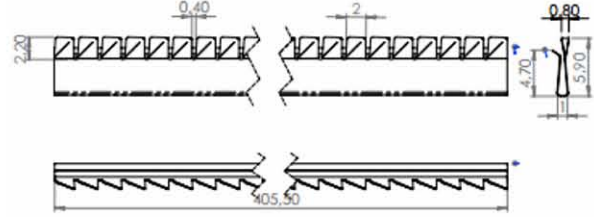
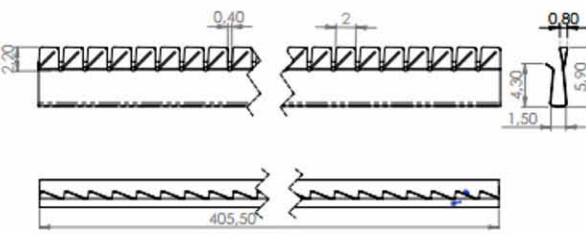
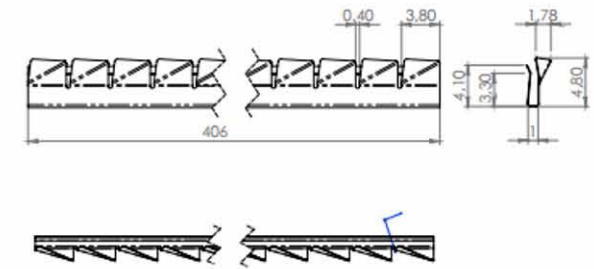
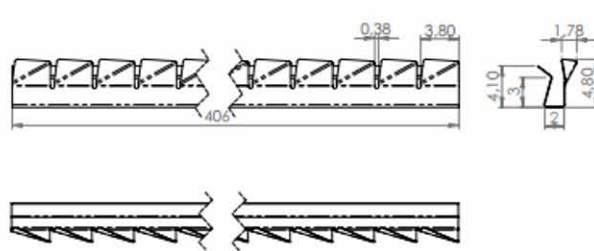
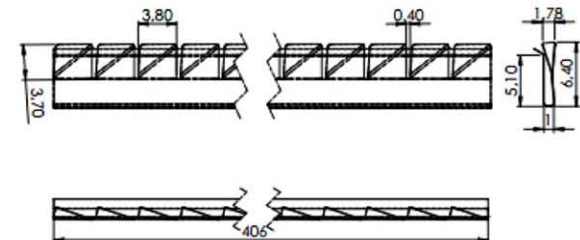
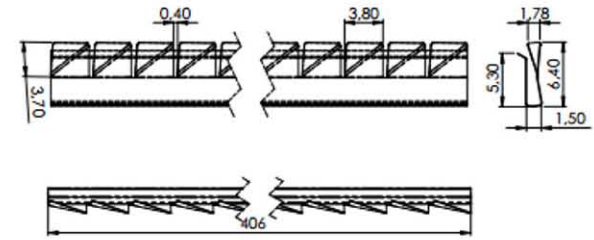
CB-0017**CB-0018****CB-0019****CB-0020****CB-0021****CB-0022****CB-0023****CB-0024****CB-0025****CB-0026**

COPPER BERYLLIUM FINGER STRIPS/CB

CB-0007

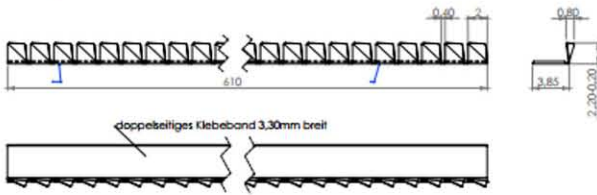

CB-0008

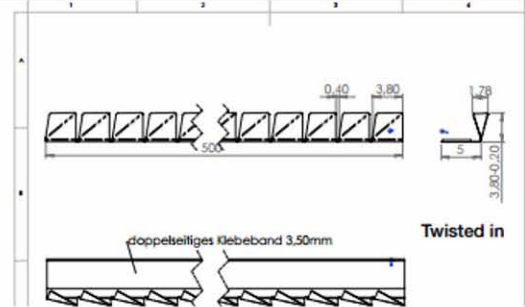

CB-0009

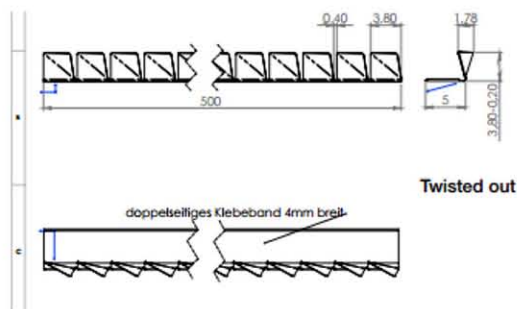

CB-0010

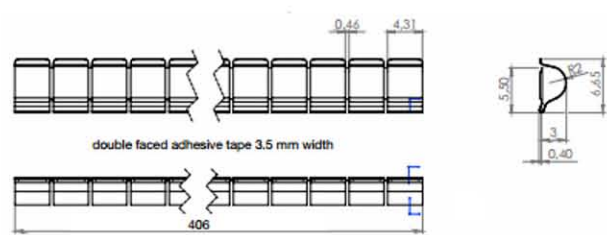

CB-0011

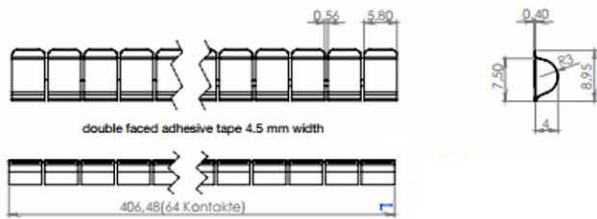

CB-0012

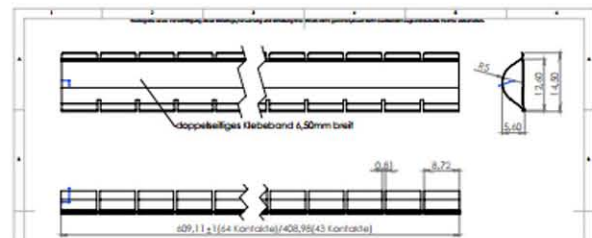

CB-0013

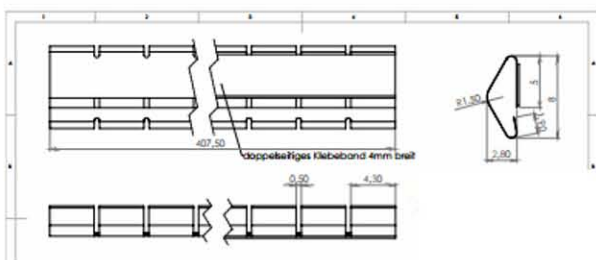

CB-0014

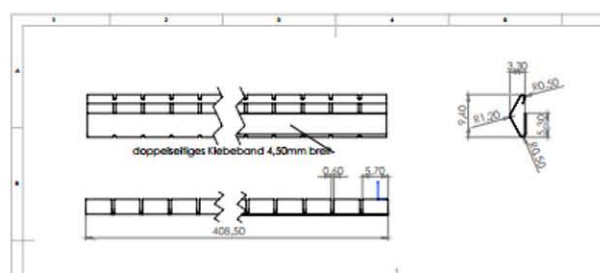

CB-0015



CB-0016

