

# COPPER BERYLLIUM FINGER STRIPS/CB



## Various selection of Copper Beryllium Finger Strips

### Feature

- Copper beryllium owes its wide range of application to the unique performance qualities it has:
  - extraordinary elasticity
  - strength
  - fatigue strength
  - high conductivity
  - resistance against environmental influences such as ozone, epipolar rays and light, also against solvents and corrosion.
- Furthermore, copper beryllium can be used under a wide temperature range and is not burnable or flammable. It does not evolve gas either. If handled correctly, it acts self purifying, for example when it is employed as a door shield for opening and closing.

### Technical Data

Specific gravity	8,4 g/cm <sup>3</sup>
Fusing point	900 °C
Coefficient of expansion (20-200 °C)	17 10 <sup>-6</sup> /°C
Thermal conductivity	0.27 cal/cm s °C; 1.13 W/cm °C
Diamond pyramid hardness	350-430 kp/mm <sup>2</sup>
Tensile strength	1200-1450 N/mm <sup>2</sup>
Fatigue strength, load application 10 <sup>8</sup>	250-290 N/mm <sup>2</sup>
Modulus of elasticity	135000 N/mm <sup>2</sup>
Torsion modulus	47000 N/mm <sup>2</sup>
Spring bending limit	820-950 N/mm <sup>2</sup>
Electric conductivity	12.5-13 m/Ωmm <sup>2</sup>

Plating finishes
-01 Bright finish
-02 Tin plated
-03 Silver plated
-04 Nickel plated
-05 Gold plated

Ordering information	Part No.	Finish-ID.	length (mm)
CB-	xxxx	-	xxxxx

### CB-0002

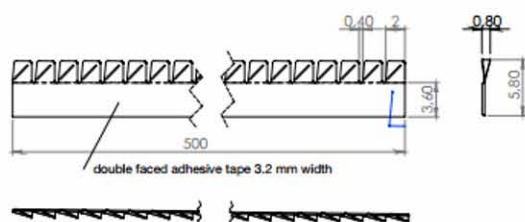

### CB-0004

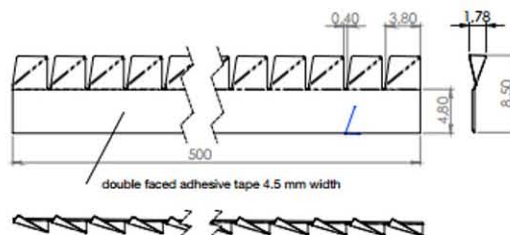

### CB-0005

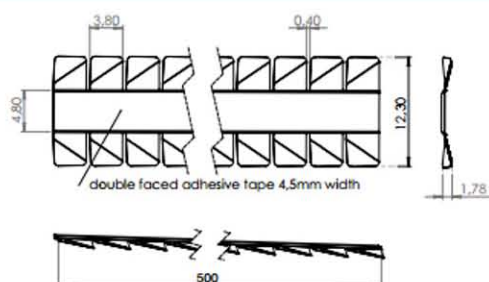

### CB-0006

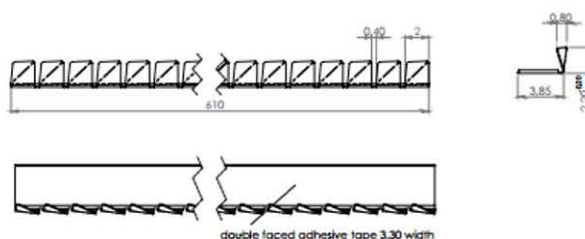

Unit: mm

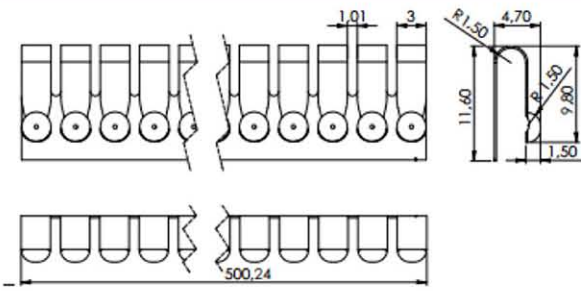
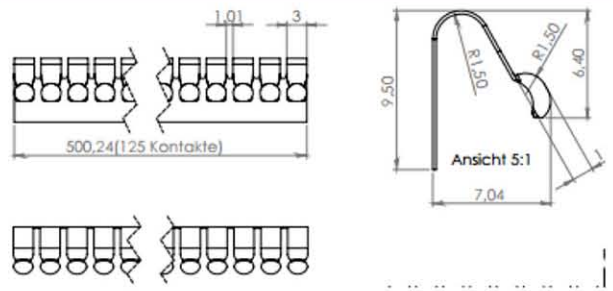
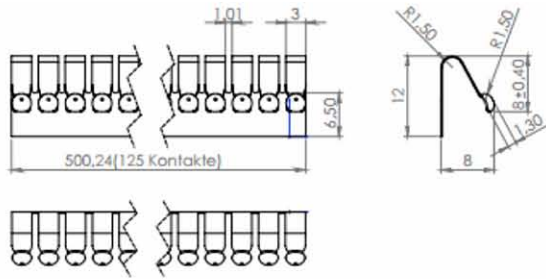
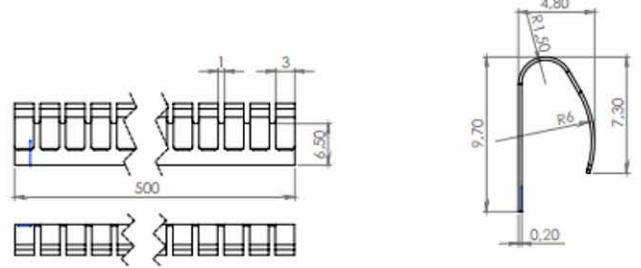
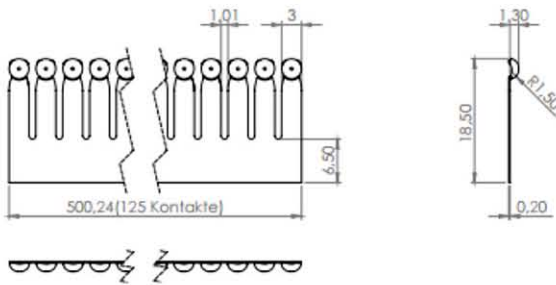
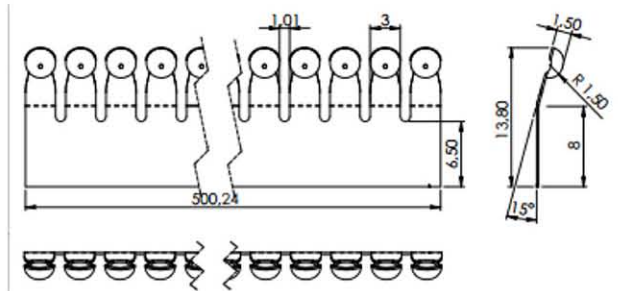
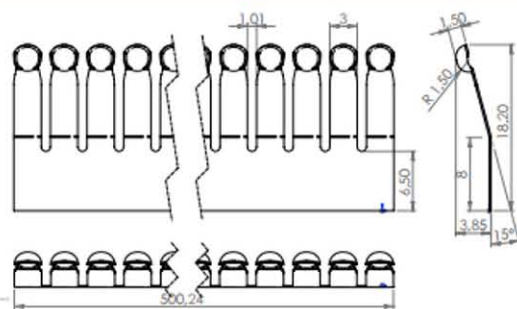
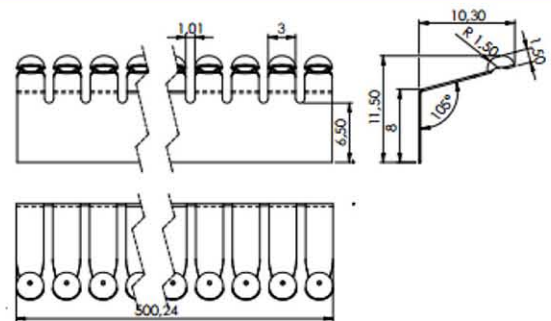
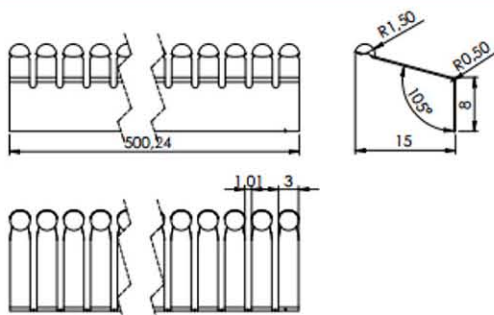
**CB-0049****CB-0050****CB-0051****CB-0057****CB-0059****CB-0060****CB-0061****CB-0062****CB-0063**

CB-0027

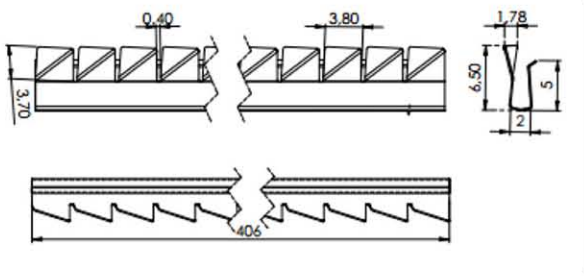

CB-0034

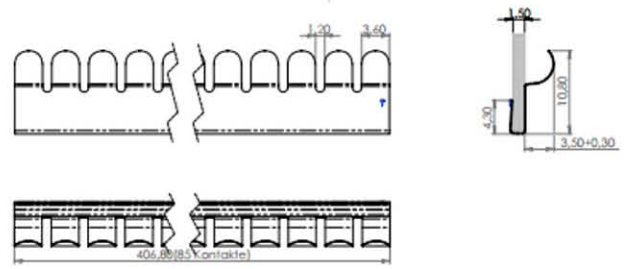

CB-0036

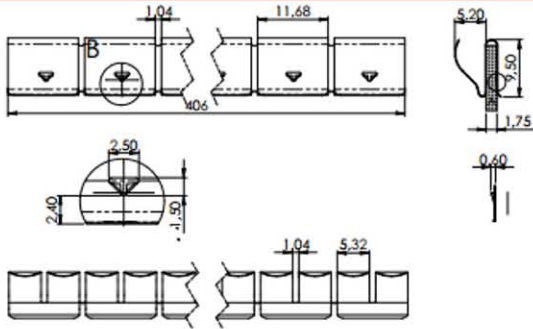

CB-0037

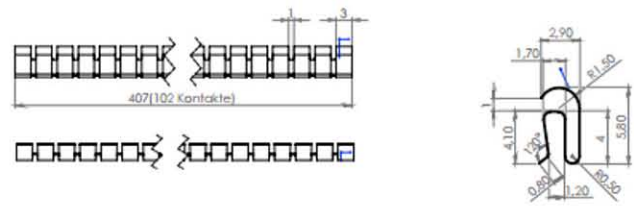

CB-0038

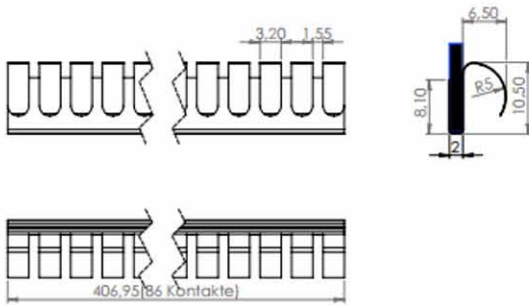

CB-0039

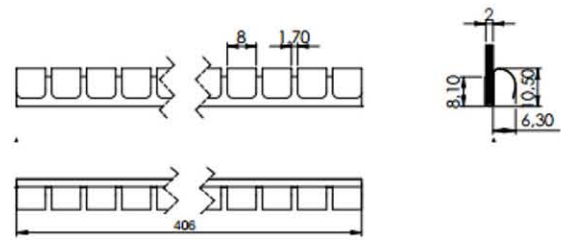

CB-0042

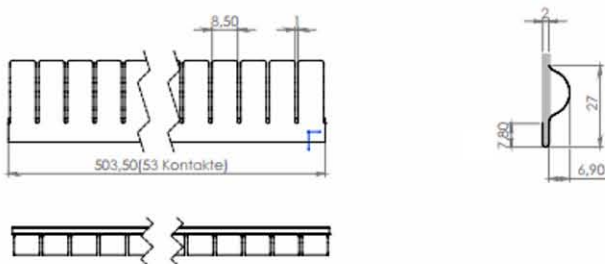

CB-0044

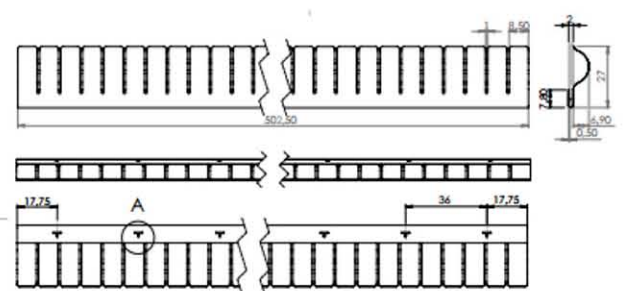

CB-0045

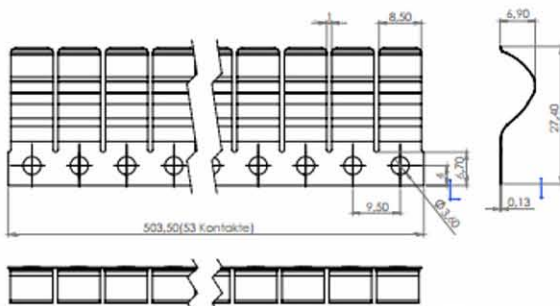

CB-0048

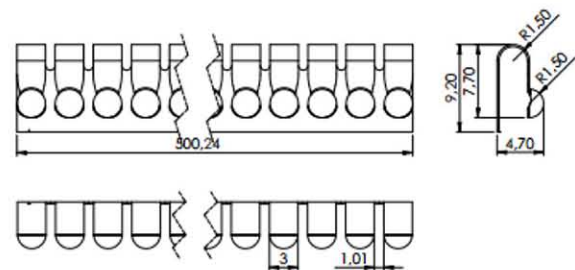

Unit: mm

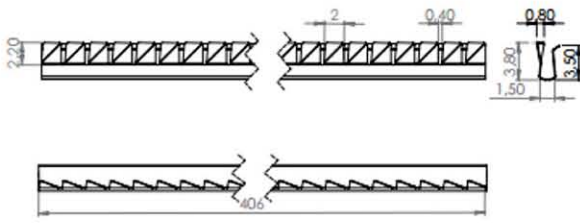
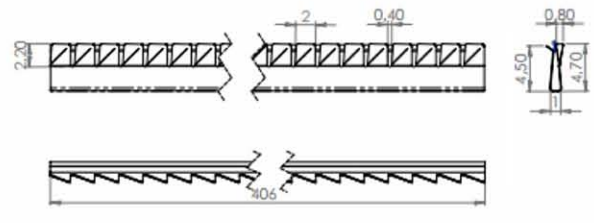
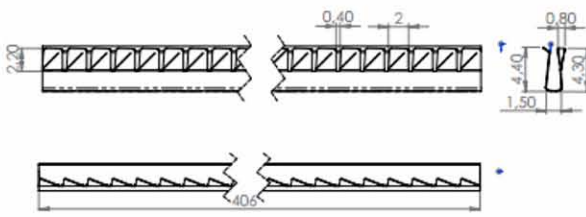
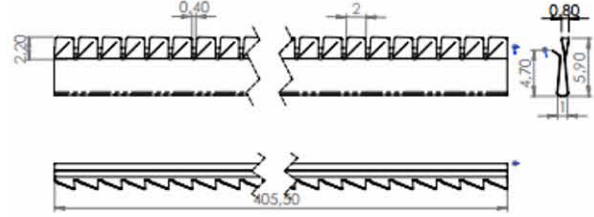
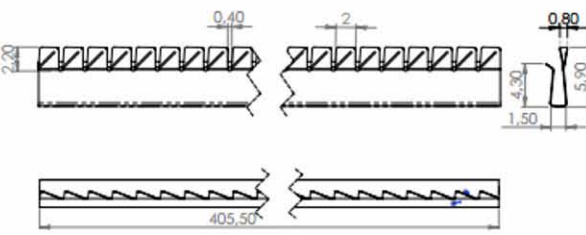
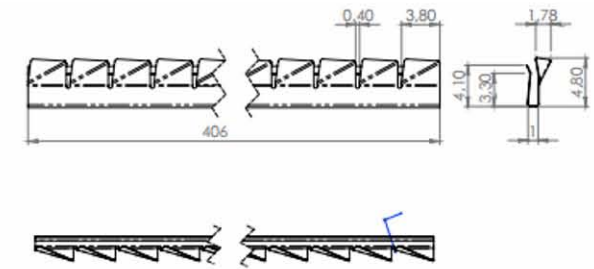
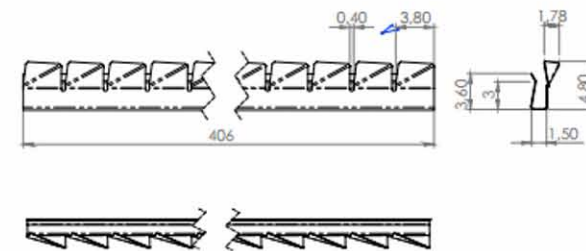
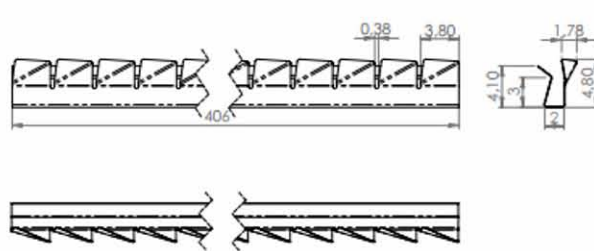
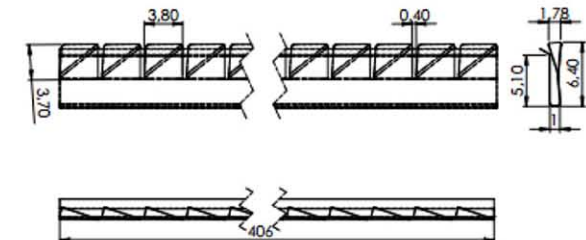
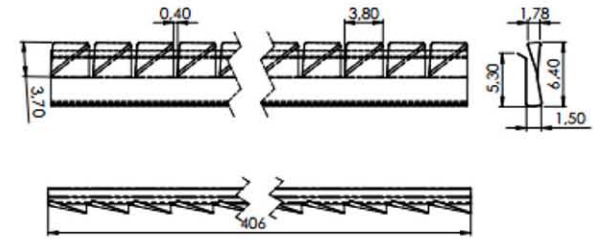
**CB-0017****CB-0018****CB-0019****CB-0020****CB-0021****CB-0022****CB-0023****CB-0024****CB-0025****CB-0026**



# COPPER BERYLLIUM FINGER STRIPS/CB

CB-0007

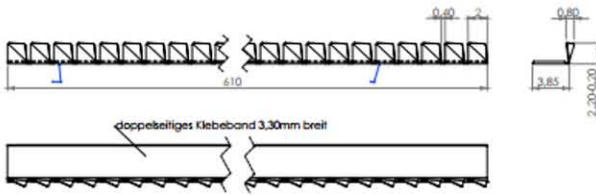

CB-0008

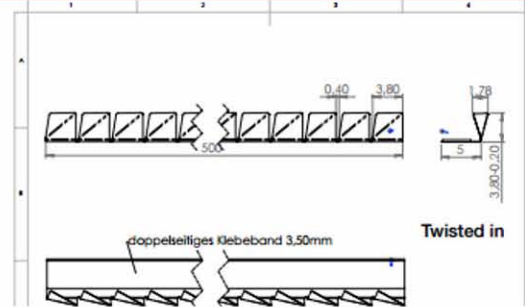

CB-0009

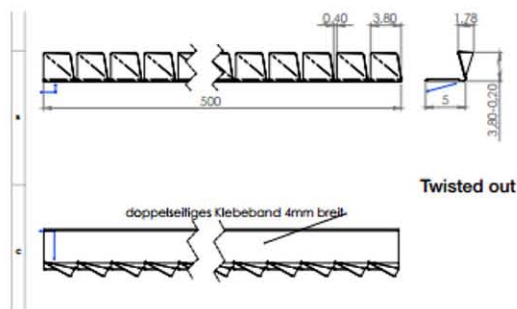

CB-0010

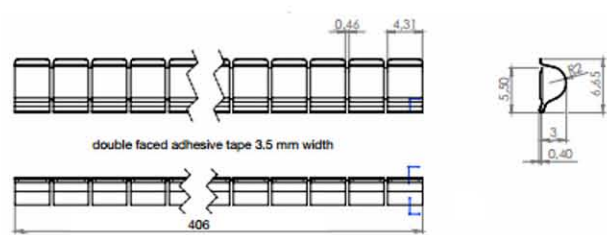

CB-0011

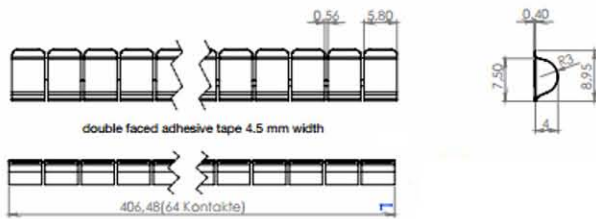

CB-0012

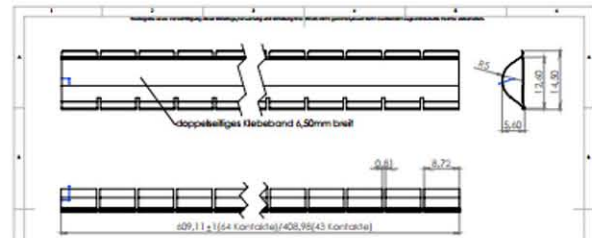

CB-0013

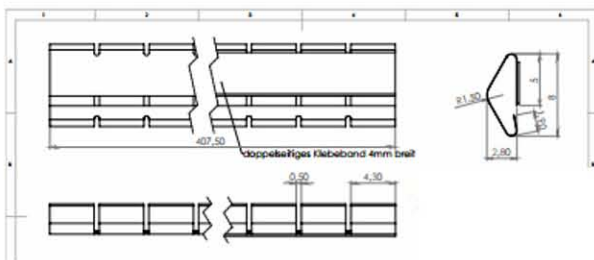

CB-0014

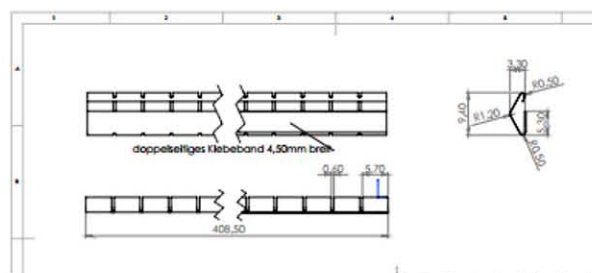

CB-0015

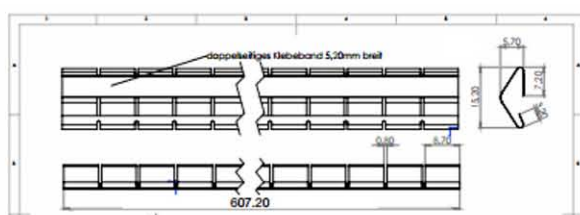

CB-0016

